

Montagewinkel-Montageanleitung

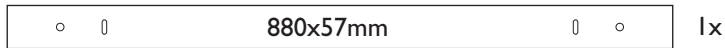

ACHTUNG!

Bei Trockenausbau und anderem Mauerwerk muss der dafür entsprechende Spezialdübel verwendet werden.

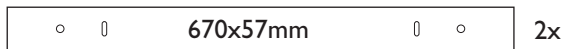
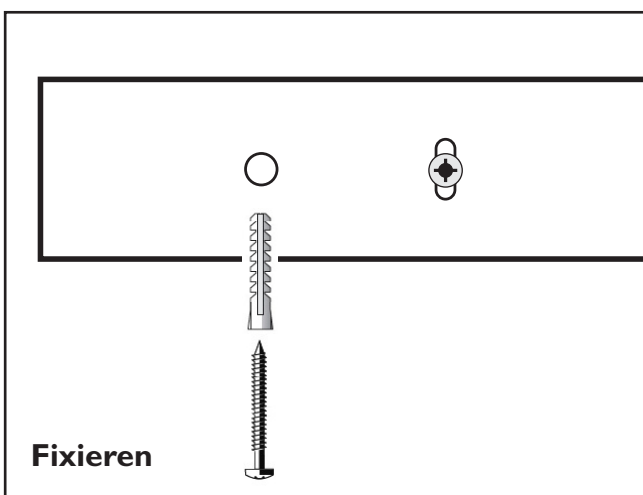
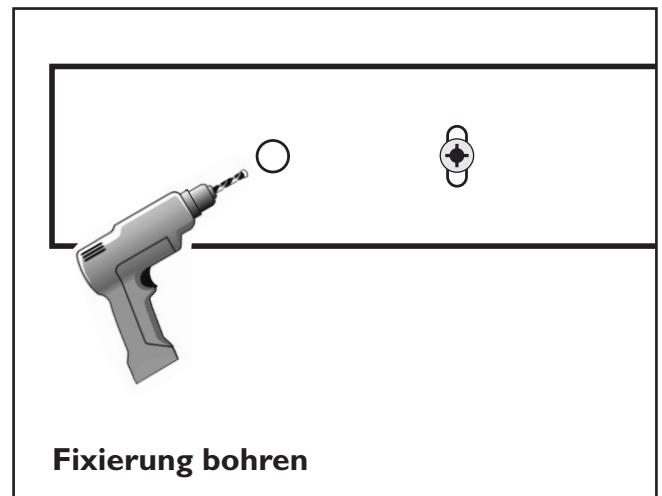
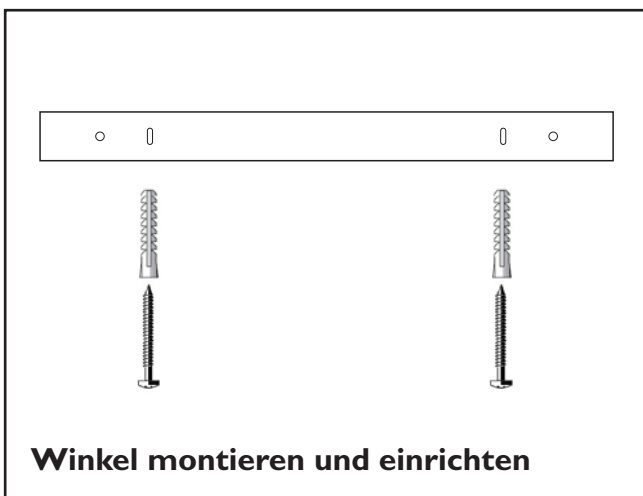
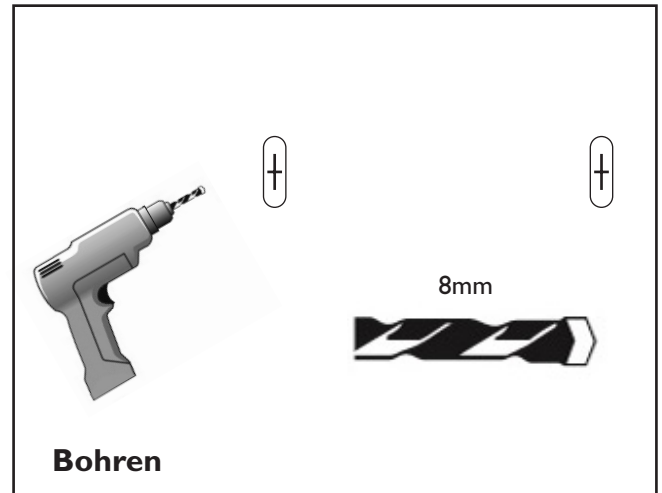
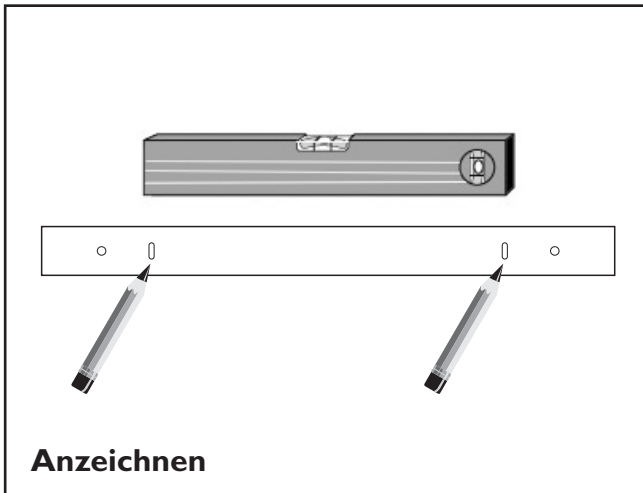

Durch die Fixierung wird die Absenkung der Wanne verhindert.



POLYPEX®

www.Badewannen.at